

8-key Hulled RF LED Remote Controller Manual

Product Specifications

Model Name: LP-RFT8A



This product warranty is 2 years (exclude the artificial situation of damaged or overload working)

Before installing this product, Please read this manual carefully. Ensure full understanding of this specification to avoid unnecessary damage and additional costs.

Product Description

8-key RF controller adopts the advanced micro control unit, it is used for controlling a variety of lamp whose source of light is LED. For instance, point source of light, flexible light strip, wall washer lamp, glass curtain wall light and so on; it has many advantages such as low price, easy connection and simplicity to use. Meanwhile, you could adjust brightness, static color choices and various dynamic changes in lighting effects through wireless remote control. And according to the actual need of customers, it can carry out jumpy changing, gradual changing, stroboflash and other effects of change.

External Dimension

(Controller)



(Remote control)



(Packing size)

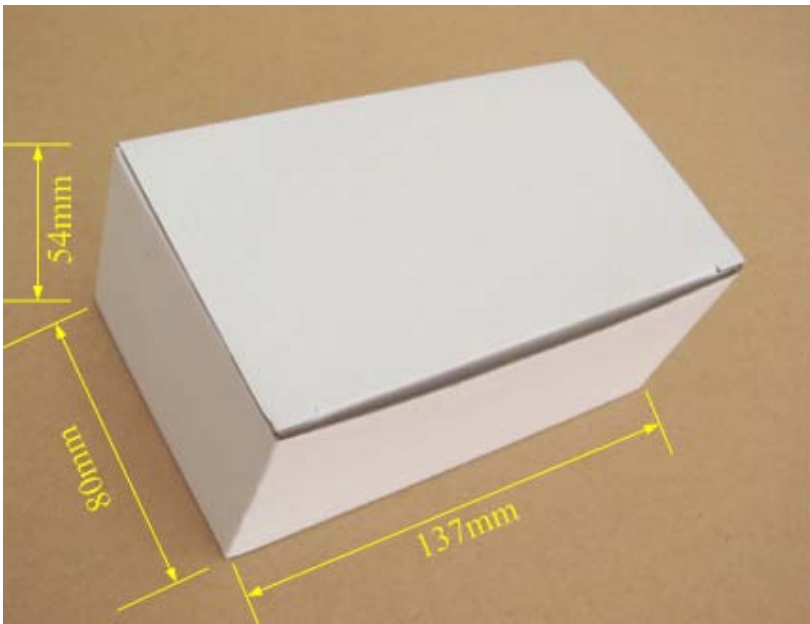

Technical Parameters

Working temperature	-20-60°C
Supply voltage	DC5V, 12V~24V optional (specify the required voltage on orders)
Output	3 channels
Connecting mode	common anode/cathode optional (specify the required voltage on orders)
External dimension	L121*W75H25 mm
Packing size	L137*W80*H54mm
Net weight	250g
Gross weight	285g
Static power consumption	<1W
Output current	6A(each channel)
Output power	5V:<90W, 12V:<216W, 24V:<432W

Interface Specifications

Power input interface:



Adopt the Screw terminal

Load output interface:











Adopt the Screw terminal

Direction for use

- Connect the load wire at first, following by the power wire; **Please ensure short circuit can not occur between connecting wire before you turn on the power;**
- Adopt film button control and RF control, function of remote control is with the same of panel. There are 8keys in total, function of each button as below::



Symbol	Button Name	Instruction
	On/Off	The output switch. In any state, you could turn on or turn off the output of controller;
	Pause	Play/Pause key. When you want to see the static effect of led , you may press this button to pause.
	Speed up	The speed changing progression will add one when you press the button every time, there are 100 steps ;
	Speed down	The speed changing progression will subtract one when you press the button every time.
	Brightness up	Adjusting brightness button, the brightness progression will add one when you press the button every time, there are 256 steps;
	Brightness down	The brightness progression will subtract one when you press the button every time;
	Mode up	Pattern function key, up direction, there are 25 programs in all.
	Mode down	Down direction.

- Each press, the green light flash one time, indicating that has entered the next state.
- Standard color changes as follows:

Items	Patterns	Remarks	Items	Patterns	Remarks
1	Static red	Brightness is adjustable,Speed is unadjustable.	14	Green stroboflash	Speed and Brightness are adjustable
2	Static green		15	Blue stroboflash	
3	Static blue		16	Yellow stroboflash	
4	Static yellow		17	Purple stroboflash	Brightness is unadjustable,Speed is adjustable.
5	Static purple		18	Cyan stroboflash	
6	Static cyan		19	White stroboflash	
7	Static white		20	R/B crossfade	
8	Three-color jumpy changing	Speed and Brightness are adjustable	21	B/G crossfade	Speed and Brightness are adjustable
9	Seven-color jumpy changing		22	G/R crossfade	
10	Three-color gradual changing	Brightness is unadjustable,Speed is adjustable.	23	All fade out&fade in	
11	Seven-color gradual changing		24	Random stroboflash	
12	Three-color flowing	Speed and Brightness are adjustable	25	Automation	1~24
13	Red stroboflash				

Typical Applications

Application Circuit:

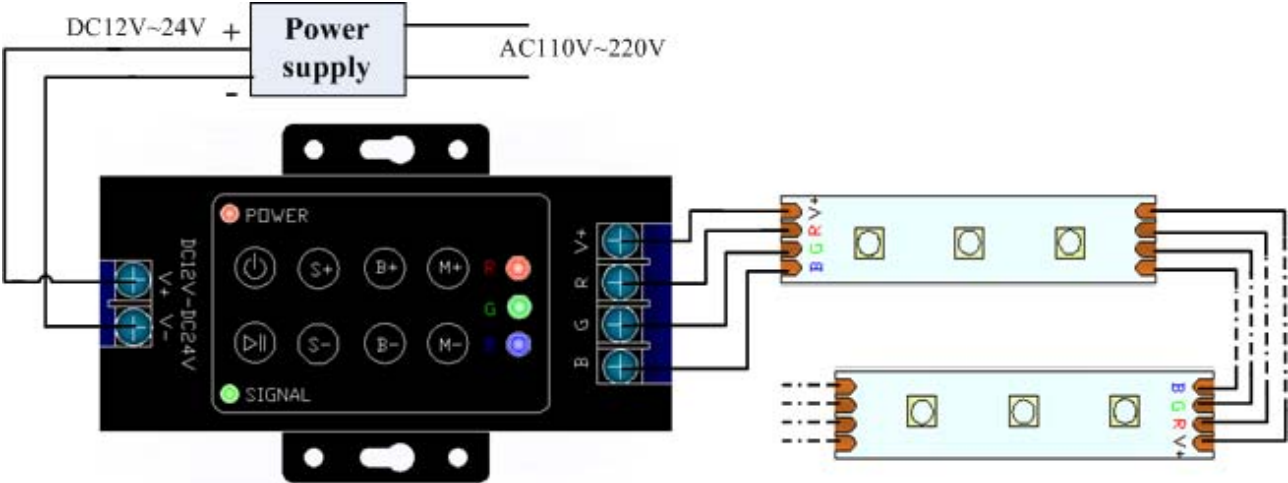

Notes

1. Supply voltage of this product is DC12V~24V, never connect to others or AC220V.
2. Wireless Remote Control is powered by DC12V battery, if Stretch the antenna, it would Control better.
3. Lead wire should be connected correctly according to grade that connecting diagram offers.
4. This product is not to overload;
5. Warranty of this product is two years, but exclude the artificial situation of damaged or overload working.

Common Problems

Problems	Possible cause	Solution
1. Lamp does not light after power	Power cord is not properly connected, or there is not output switching power supply	Connect the power cord properly or replay the power
	Lamp power cord is not connected or short circuit	Connected lighting power cord
2. After connecting some of the load the controller does not work	The connected load is too large, so that it has burned in some of the components of the controller	Replace parts of components or replace the controller